

# RGB Steuerung 9A 12-24V

## rgb controller 9A 12-24V



### Technische Daten / technical data

Sender / controller		Empfänger / receiver	
Maße / measurements (LxBxH)	104x60x9mm	Maße / measurements (LxBxH)	135x30x20mm
Frequenz / frequency	433,92MHz	Eingangsspannung / input voltage	12-24V DC
Reichweite / distance	40m	max. Strom / max. current	3CHx3A 9A
Ta	-30°C - +55°C	max. Leistung / max. power	108W/216W (12V/24V)
Artikelnummer / part number	071-0018-001	Ta	-30°C - +55°C

### Zeichnung / drawing

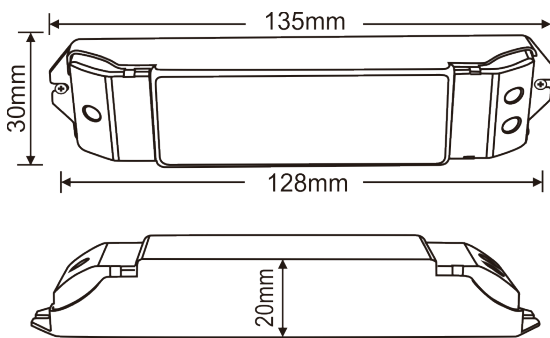

Receiver

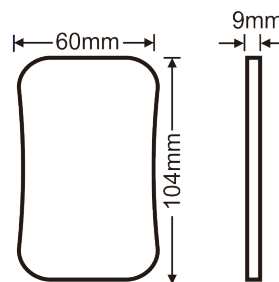

RF remote

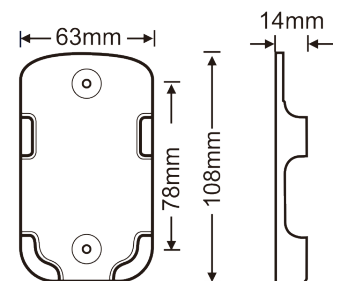

Remote holder

